

ELECTRO-PROPORTIONAL VALVES—DIRECTIONAL CONTROL

SP10-20 Poppet, 2-Way, Normally Closed

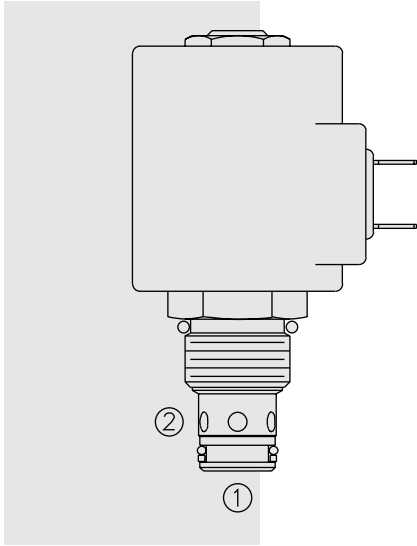

DESCRIPTION

A proportional solenoid-operated, 2-way, poppet-type, normally closed, screw-in hydraulic cartridge valve for low-leakage blocking and load-holding applications.

OPERATION

When de-energized, the **SP10-20** acts as a check valve, allowing flow from ① to ②, while blocking flow from ② to ①. When energized, the poppet lifts to open the ② to ① flow path. Flow is proportional to current applied to the coil.

Note: If low voltage is expected on the machine, 12 or 24 volt systems will require the use of 10 volt or 20 volt coils respectively. See "SP Valves and Coil Operating Parameters," page 2.002.1.

FEATURES

- Industry-common cavity.
- Efficient wet-armature construction.
- Continuous-duty rated coils.
- Optional waterproof E-Coils rated up to IP69K.

RATINGS

Operating Pressure: 250 bar (3625 psi)

Flow: 68 lpm (18 gpm) at 34.5 bar (500 psid)

Hysteresis: Less than 5% up to 75% of I-max.; Less than 10% above 75% of I-max.

Max. Internal Leakage: 5 drops per minute at 250 bar (3625 psi)

Temperature: -40 to 120°C with standard Buna seals

Filtration: See page 9.010.1

Fluids: Mineral-based or synthetics with lubricating properties at viscosities of 7.4 to 420 cSt (50 to 2000 sus)

Installation: No Restrictions. See page 9.020.1

Cavity: VC10-2; See page 9.108.1; **Cavity Tool:** CT10-2XX; See page 8.600.1

Seal Kit: SK10-2X-T; See page 8.650.1

Coil Nut: Part No. 7004400;

For E-coils manufactured prior to 1-1-04, see page 3.400.1 for coil nut info.

SYMBOLS

USASI/ISO:

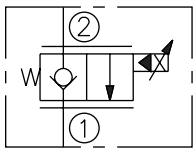

PERFORMANCE

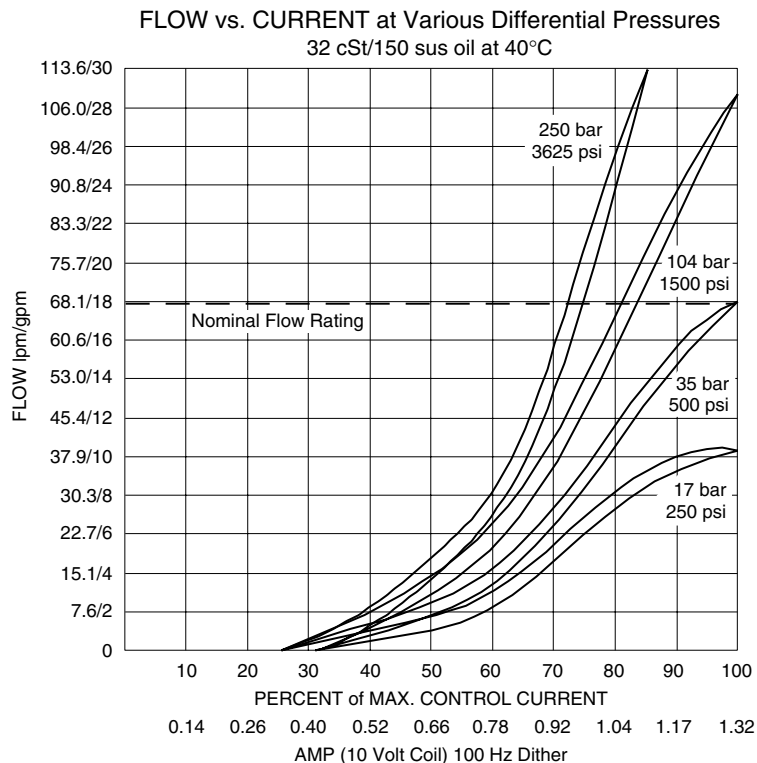
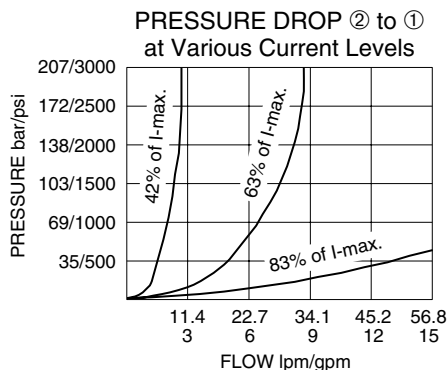
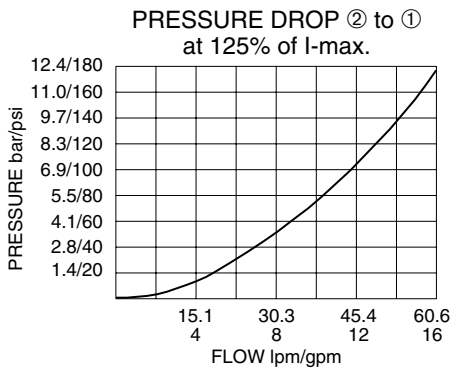

PERFORMANCE (cont'd.)

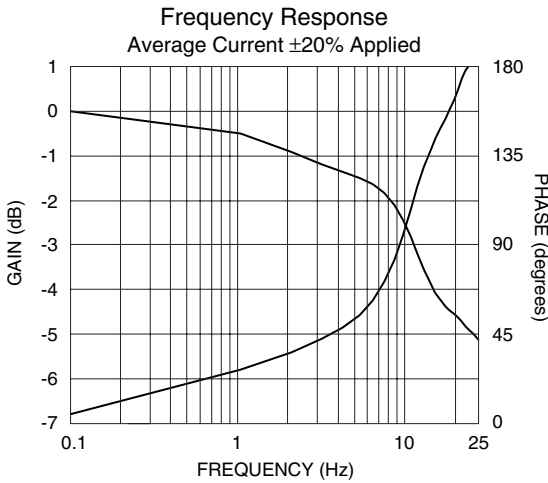

Recommended Controllers (See Section 3)

Input Sig. w/12V Coil	DIN Coil Mount	PCB Board	Metal Box	DIN Rail Mount
0-5 VDC	7114950	4000046	4000049	4000136
0-10 VDC	4000070	4000141	4000124	4000137
4-20 mA PWM	4000123	4000143	4000130	4000139
	—	4000144	4000133	4000140
w/24V Coil				
0-5 VDC	4000161	4000194	4000174	4000136
0-10 VDC	4000165	4000141	4000182	4000137
4-20 mA PWM	4000169	4000143	4000186	4000139
	—	4000144	4000133	4000140

DIMENSIONS

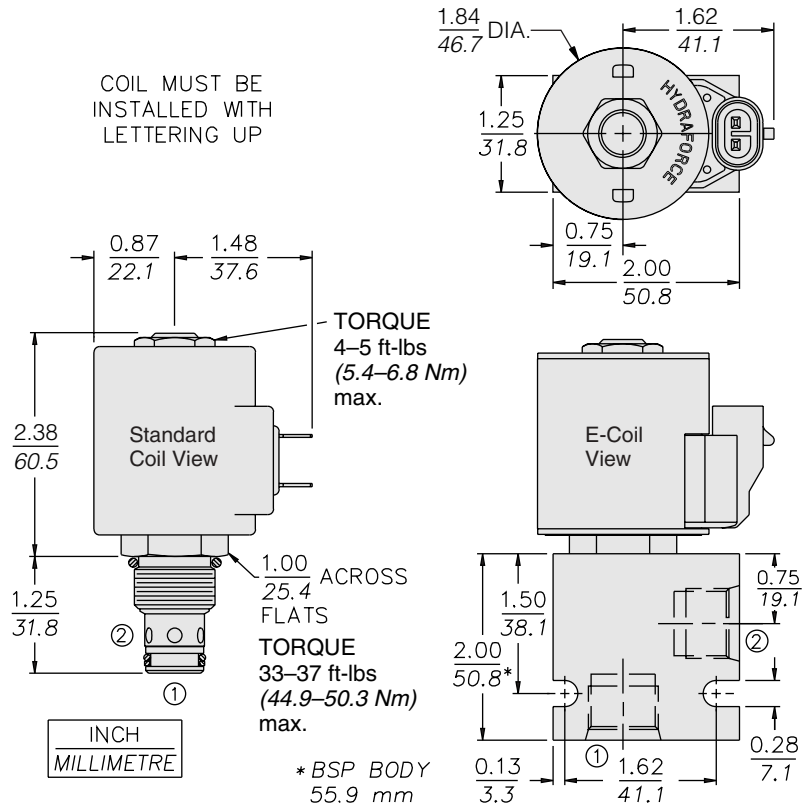

MATERIALS

Cartridge: Weight: 0.16 kg. (0.34 lbs.); Steel with hardened work surfaces. Zinc-plated exposed surfaces; Buna N O-rings and back-ups standard.

Standard Ported Body: Weight: 0.16 kg. (0.35 lbs.); Anodized high-strength 6061 T6 aluminum alloy, rated to 240 bar (3500 psi); See page 8.010.1. Ductile iron and steel bodies available; consult factory.

Standard Coil: Weight: 0.27 kg. (0.60 lbs.); Unitized thermoplastic encapsulated, Class H high temperature magnetwire; See page 3.200.1.

E-Coil: Weight: 0.41 kg. (0.9 lbs.); Perfect wound, fully encapsulated with rugged external metal shell; Rated up to IP69K with integral connectors; **Note: See page 3.400.1 for all E-Coil retrofit applications.**

TO ORDER

